



COMMAND FUSION

PRODUCT CATALOGUE

Contents

01 - 02	Key Advantages	Why choose CommandFusion?
03 - 04	CFLink	Why choose CFLink?
05	Solo	All-In-One IP Control system
06	Nano	Ultrasmall Modular IP Control System
07	CARDS	Available plugin cards
08	Diagram	Solo & Nano
09	iViewer	Control software for mobile devices
10	DIN-MOD4	DIN Rail 4-slot modular controller
11	MOD4	Rackmountable 4-slot modular controller
12	Modules	Available modules
13	MOD-HRY2	2-channel 15A latching relays
14	MOD-RY4	4-channel 5A relay module
15	MOD-SSRY4	4-channel 2A solid-state module
16	MOD-LRY8	8-channel relay module
17	MOD-IO8	8-channel I/O module
18	MOD-COM4	4-channel COM module
19	MOD-IR8	8-channel IR module
20	CF Mini	Miniature integrated controller
21	LAN Bridge	Ethernet CFLink bridge
22	SW16	16-channel button interface
23	IR Blaster	IR blaster and receiver
24	IR Learner	Infra-red learner
25	IRE-Slim	Ultraslim Infrared Emitter
26	RACKIT	Rack-mount kit
27 - 28	Diagram	Residential - Whole House
29 - 30	Diagram	Commercial Office Building
31	Diagram	Boardroom
32	Notes	-

Product specifications are subject to change.

For the latest up to date product specifications, please visit our website:

www.commandfusion.com

About Command Fusion

Our Philosophy

The team at CommandFusion (CF) is passionate about making automation software and hardware simple (yet powerful), reliable and affordable. We have gone to great lengths to source like-minded veterans throughout the world to make this a reality.

We also recognise that community efforts are often more powerful and productive than our own, and as such our communication protocols for both software and hardware are fully published in detail. Community involvement is a vital part of our product evolution, utilising online groups and chat systems where CommandFusion engineers and support staff regularly engage with customers. This streamlines our support system whilst providing excellent resources to all customers globally.

Product Design

In both hardware and software design, our focus is to ensure flexibility, reliability, interoperability and planning for the future.

With software, this is reflected in the flexibility of GUI design, and a Regular Expression and JavaScript engine which can handle two-way communication with any networked device, parsing data into meaningful UI elements.

With hardware, CF has chosen a wired approach which can then be made wireless. Wired solutions are inherently more reliable and secure. CFLink BUS testing has been undertaken for over a year prior to commercial release, and our products are proven capable of withstanding common miswiring faults, voltage fluctuation and drops.

Manufacturing

Components for CF hardware are carefully chosen, the majority of which are either from the USA or Japan. Most of our hardware products are over 50% content from the USA, and the contract manufacturer is a large American contract manufacturer with medical and military certification.

Final assembly is currently executed in Malaysia, and shipping is done from our warehouse in Malaysia. Shipping and RMA hubs are constantly added in strategic locations and steps are currently underway for North America and EU to have local hubs or representatives.

Environment

We also strive to ensure our products are environmentally friendly, with brown cardboard packaging and minimal or no use of plastic packaging.



Why Choose CommandFusion?

CommandFusion designs and manufactures a range of automation and control hardware and software.

Create the ultimate control system

Combine the flexibility of the modular hardware range with the power of iViewer on your mobile device to control almost anything, whether its is a residential, commercial or any other project with automation.

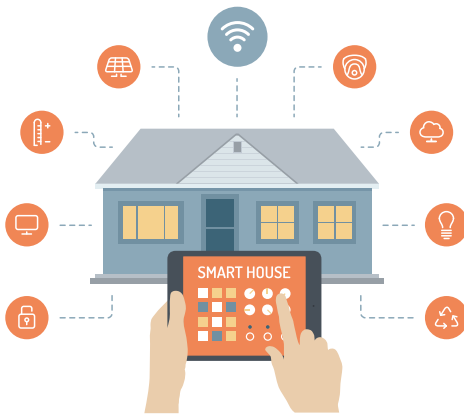

Control your house with CommandFusion

Use CommandFusion to create the ultimate smart home. Think of our hardware as the connectivity to all your stand-alone items. Then use iViewer to control everything from one easy-to-access control panel - your phone or tablet!

Some of the systems that are easily connect with CommandFusion:

- **Home Theater (TV, Surround Sound, Projector)**
- **Lighting, Blinds, Curtains**
- **Heating/Cooling (HVAC)**
- **Security Alarm, CCTV**
- **Door Locks, Access Control**

Build your system the way YOU want it

Because of its modular design, it's super easy to design a control system using CommandFusion hardware that suits your projects' unique requirements and budgets.

Need more infrared outputs? Simply add a MOD-IR8 module to your MOD4! Then easily expand your home automation network into other areas by adding new devices via the CFLink bus or a standard ethernet network.

This means that you aren't paying for features you don't need, and the system can grow as you expand it throughout your home or office.

When you have your control hardware set up, easily control it (and any other IP-enabled device) with iViewer for Mobile Devices. iViewer allows you to create a graphical user interface that looks any way you want, and right on your own iOS or Android device!



Perfect for any user: DIY or Professional Integrator

Whether you are a DIY user or a professional integrator, CommandFusion products are designed for you.

Integrators will enjoy the modular design, and the cost effectiveness will allow you to compete with integrators that are using much more elaborate systems.

DIY users will benefit from the features and potential savings. Support at CommandFusion is unparalleled with easily accessible service.

Abundant applications

CommandFusion products are not limited to home automation. They have been used in many different applications, some examples of these are:

- Commercial spaces
- Marine vessels & Aircraft
- Luxury automobiles
- Emergency response vehicles
- Educational institutions
- Houses of worship
- Residential applications
- OEM products



Open Protocols - Communicate with any system

Control is limitless. We want to allow you to choose components that best suit your requirements, which is why we have implemented open protocols which allow for easy communication with other control systems and services.

This means you can easily connect CommandFusion hardware and software with other brands of control systems such as Crestron, Control4, Global Cache etc.

iViewer for Mobile Devices

Our app for Apple iOS and Android devices allows you to control any IP-enabled devices, including our own hardware, directly from your iPad, iPhone, Android device, etc.

- Fully customisable GUI
- Control anything via Ethernet / Wi-Fi
- Dynamic feedback processing
- Javascript API
- Utilise advanced device sensors and features
- iOS/Android support
- Choose a version to suit your requirements

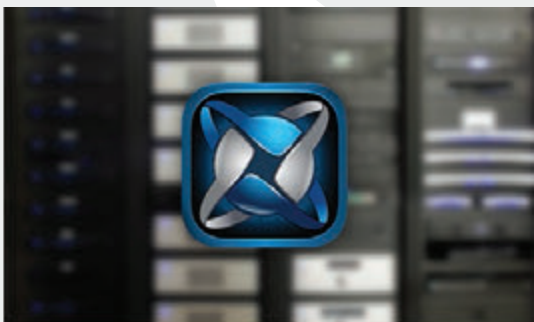

Hardware Agnostic

iViewer is hardware agnostic, where it does not rely on a certain type of equipment to be able to talk to your devices.

Examples of products iViewer can integrate with:

- CommandFusion hardware
- Crestron, AMX, Control4, RTI
- Lutron, C-Bus
- Zigbee, Z-Wave, Insteon
- KNX
- Global Cache
- RGB Controllers

Hardware Overview

CommandFusion manufactures a range of automation and control hardware, accessible to professional integrators and DIY users.

- Modular approach - add modules and other devices to create a tailored system that grows with you
- Extremely cost effective
- Distributed intelligence - a single processor failing will not affect other units
- Ethernet connectivity and CFLink bus
- Industry-leading 5 year warranty
- Extremely low power consumption. 30-70% lower than similar products



What is CFLink

CFLink is the communication bus used by our hardware. It is a 5-wire RS485 bus that is capable of carrying both power and data to devices over a maximum distance of 1.6 kilometers, not taking into account of power loss. Up to 238 devices can exist on a single network, and multiple CFLink networks can communicate with each other via Ethernet, providing an endlessly scalable system.

Cabling

CFLink can run on any cable with 5 or more cores, including CAT5/6 and 2-pair shielded cable. When using CAT5/6, you should use one pair for voltage+ and one pair for voltage- to decrease the voltage drop over longer runs.

CFLink can use any wiring topology, including daisy-chaining between devices, home runs or any combination of both. Most existing systems use a master-slave approach on their bus but CFLink is a true Peer to Peer bus where each device is an equal. This distributed intelligence results in a more reliable system because each unit remains fully functional even if one of the devices drops off the network whereas a master-slave system is completely dependent upon the master.

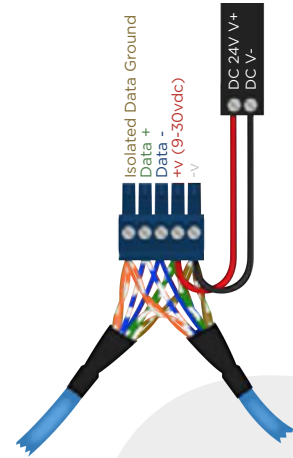

CFLink vs Standard RS485

Power Requirements

Existing powered 4-pin RS485 buses have some common issues which CFLink overcomes. The first is a fixed voltage requirement which results in a low tolerance for voltage drops over longer cable distances. CFLink operates from 9-30v DC with low power consumption resulting in exceptional tolerance for long cable runs without adding more power supplies.

The second is the addition of a 5th isolated ground for data to prevent interference from ground loops in large scale projects.

Peer to Peer Bus

Without a master, CFLink will continue to function even if multiple devices fail since each device stores its own relevant logic processing.

Device ID Conflict Resolution

Typically each device on RS485 will have its own unique ID per model, resulting in an ID conflict when multiple units of the same model are put on a single network. With CFLink, this conflict is automatically resolved with a single click of the mouse using our configuration software.

Tolerance for miswiring

CFLink devices have exceptional tolerance for miswiring, including shorting all cables together, or applying power to any pin incorrectly. Built-in fuses automatically reset once the fault is rectified and CF devices will resume normal operation.

CFLink vs Ethernet

Flexible Cabling and Topology

CFLink's wiring topology is very flexible. Ethernet would require each device to be wired to a switch or hub, whereas CFLink can loop from device to device, home run or any combination of both.

Cable Type

CFLink can use almost any cable as long as it has 5 wires (or 4 wires and shield, or even just 4 wires if that is the only available option). Ethernet is limited to particular cables - Cat5/6, etc. This has obvious advantages for retrofitting.

Cabling Distance

Ethernet can only run 100m on standard cabling whereas CFLink can run in excess of 1.6 kilometers without repeaters, fibre or other extenders.

Device Management

Each CFLink network need only take up a single IP address, allowing for ease of IP management and reduction of IT infrastructure needs.

- ✓ **High Reliability, fewer points of failure**
- ✓ **Longer cable runs (up to 1.6 km)**
- ✓ **Low Maintenance**
- ✓ **Flexible topologies and power distribution**
- ✓ **Lower hardware cost**

Reliability

- By sitting on its own isolated BUS, automation devices will continue to function in the event of network outage.
- Whereas an Ethernet system can be challenging with issues arising from cabling, routers, switches, Wi-Fi, IP conflicts, rogue devices and so on, automation on its own network greatly increases its reliability.
- Traffic on Ethernet can be very significant in today's environment with the use of IP cameras, media players and so on. By being on its own bus, CF hardware is unaffected by Ethernet traffic and additionally not adding to it.

Cost

- Implementing CFLink is very much cheaper compared to Ethernet. Cables can be easily looped or joined together without the need for switches, routers, repeaters, fibre-extenders and expensive patch cables.

Wi-Fi

- Wireless technology is inherently less reliable than a wired system. It is possible to convert CFLink to Wi-Fi by use of off the shelf wireless bridges or routers if needed, but it does not need to be built in to all of our hardware.
- Many commercial installations do not permit wireless networks in their offices for security purposes.

Daisy-Chain Topology

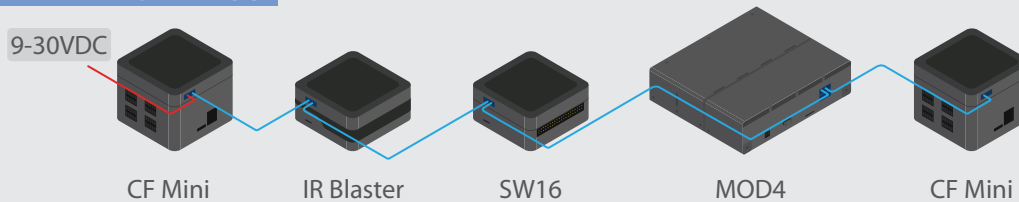

Star Topology

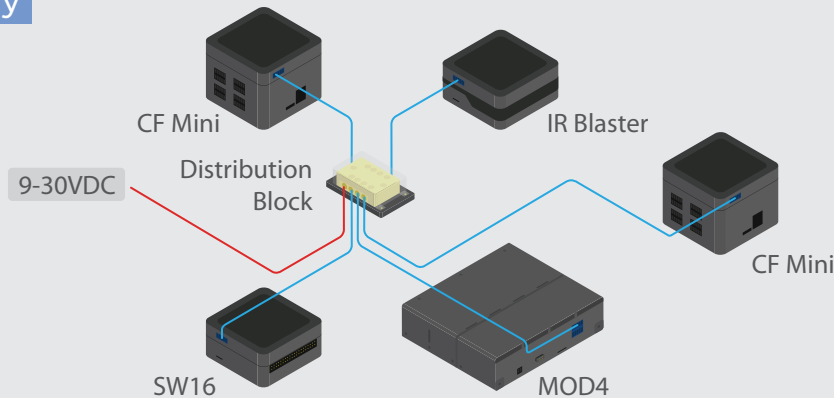

Combination of Topologies

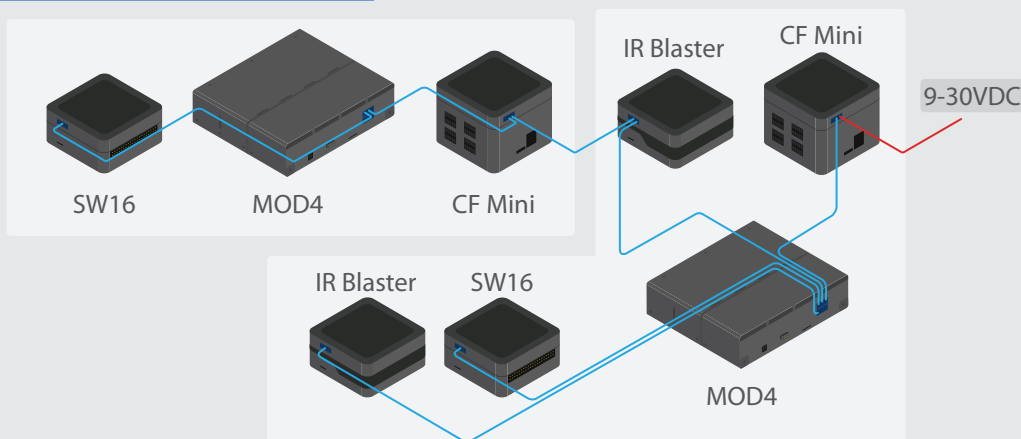

Solo

All-In-One IP Control System

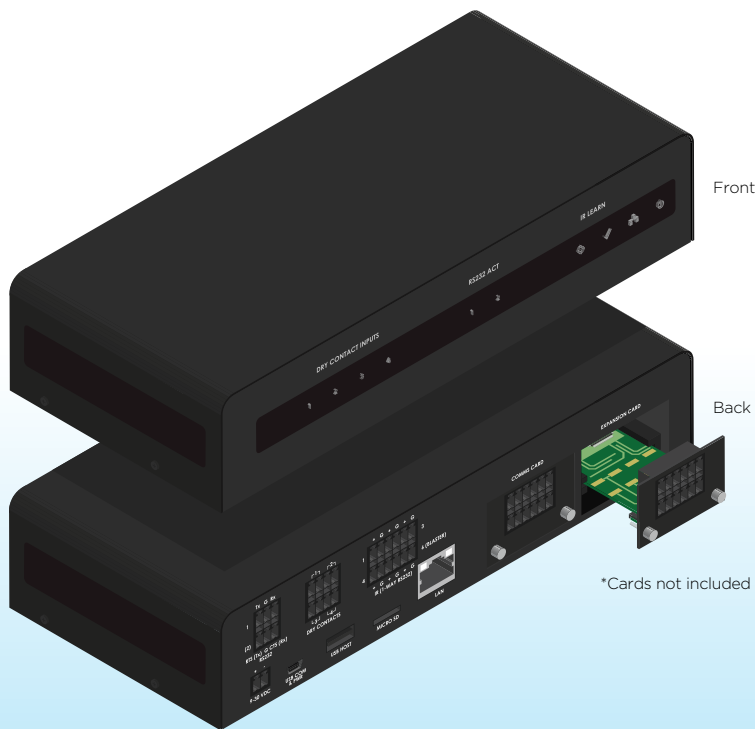

*3D rendering. Final product may change slightly.

MAIN FEATURES

- Power 9-30VDC or USB powered (5VDC)
- 1 x RJ45 Ethernet port
- 1 x communication expansion slot (Wi-Fi and future expansion)
- 1 x port expansion slot (additional IR, Relays, IO, RS232)
- 2 x RS232 (1 Port if used with RTS/CTS)
- 1 x onboard IR Receiver/Learner with IR triggered rules
- 1 x onboard IR Blaster
- 6 x IR also 1-way RS232 and PWM control
- 4 x Dry contact inputs
- Onboard real-time clock with battery backup
- 1 x USB Device for PC communication and control
- 1 x USB Host for future expansion
- Wall-mounting hole patterns
- Built-in web configuration utility
- MicroSD card slot for memory expansion

- ✓ Ethernet / Wi-Fi
- ✓ USB control & power
- ✓ Infrared
- ✓ Built-in IR Blaster
- ✓ RS232
- ✓ Built-in IR Learner
- ✓ Dry contact inputs
- ✓ Scheduling and Rules Engine

The Solo is perfect for controlling a single room, or used to create a larger control system.

Built-in Ethernet port for quick network connectivity.

Web administration page built in for simple configuration of:

- Schedules
- Rules (event triggered macros)
- Port testing and status

Includes two expansion slots to customise your controller to suit requirements:

- Easily add Wi-Fi connectivity via the first communication expansion slot. Future proof for other communication standards.
- Easily add additional control ports via the second expansion slot using our plugin cards.

Quickly and easily create a customised interface to control your system from your mobile device via iViewer.

Utilises open protocols to easily integrate with other systems.

Built-in IR Blasters on 3 sides to flood and control anything in the room.

USB device compatibility to allow for USB control and powering of the Solo.

USB Host capability for future expansion.

Nano-LAN, Nano-WIFI, Nano-E

Ultrasmall Modular IP Control System

- ✓ Ethernet / Wi-Fi
- ✓ Infrared
- ✓ RS232
- ✓ Dry contact inputs
- ✓ USB control & power
- ✓ Built-in IR Blaster
- ✓ Built-in IR Learner
- ✓ Scheduling and Rules Engine



NANO-LAN/WIFI MAIN FEATURES

- Power 9-30VDC (2-pin) or USB powered (5VDC, Mini USB)
- 1 x RS232 bi-directional port via 3.5mm 4-pin jack
- 1 x Dry Contact Input via 3.5mm 4-pin jack
- 3 x IR Emitters via 3.5mm 4-pin jack. Port 3 can be used as external IR blaster
- 1 x IR Blaster onboard (two IR diodes for long distance and wide angle coverage)
- 1 x Onboard IR Learner/Receiver, 38KHz capable
- 1 x Ethernet port, RJ45 (NANO-LAN only)
- 1 x Wi-Fi detachable antenna, RP-SMA (NANO-WIFI only)
- 1 x USB Device for PC communication and control
- 2 x Tactile switches for reset and setup
- Card edge expansion port, up to 7 NANO-E expansions
- RGB indicator ring for notifications, adjustable brightness
- Onboard real-time clock
- Wall-mounting hole patterns
- Built-in web configuration utility

NANO-E MAIN FEATURES

- Card edge expansion ports for connection to NANO-LAN/WIFI and additional NANO-E units.
- Card slot for accepting Expansion Card units (CARD models)
- RGB indicator ring to show notifications and status information, adjustable brightness
- Wall-mounting hole patterns

1. Choose LAN or Wi-Fi

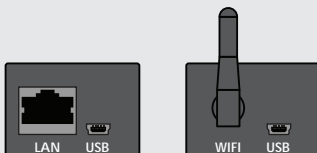

2. Add up to 7 expansion units

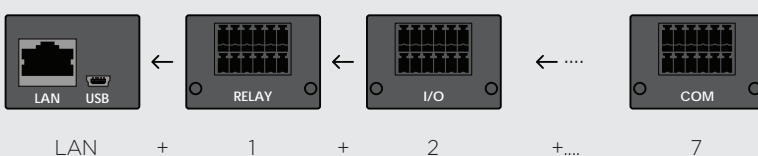

Due in the second half of 2014, the Nano is an intelligent modular IP control system used to connect any device to your network.

Select Wi-Fi or Ethernet connectivity as the base unit, then add on up to 7 expansion cards, giving you the flexibility to control as many devices as you need.

Both the Nano-LAN and Nano-WIFI base units feature a variety of on-board control ports for standalone operation, which can be expanded using the NANO-E and plugin CARD units.

Web administration page built in for simple configuration of:

- Schedules
- Rules (event-triggered macros)
- Port testing and status

Utilises openly documented protocols to allow easy integration with other systems.

Quickly and easily create a customised interface to control your system from your mobile device via iViewer.

USB device compatibility to allow for USB control and powering of the Nano and connected expansion units.

Available Plugin Cards

Communication Cards

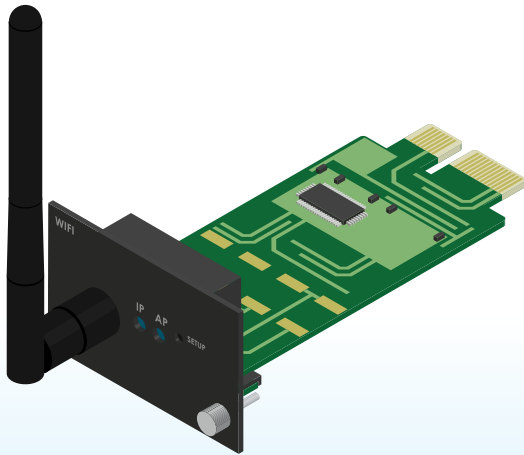

CARD-WIFI

Wi-Fi communications card
Add wireless communications to the Solo.
802.11g

*Additional communications cards coming in 2015.

Expansion Cards

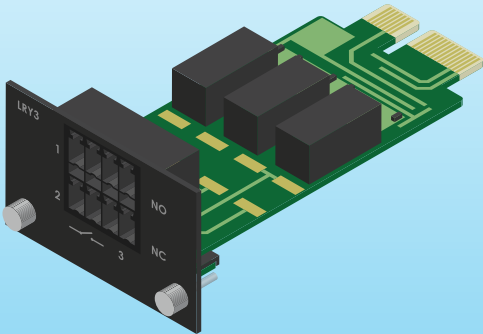

CARD-LRY3

Relay card
3 x 30VDC 1A relays (2 latching, 1 NC/NO)

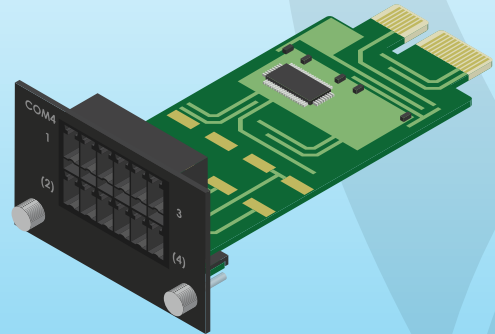

CARD-COM4

Serial port card
2-4 configurable RS232/422/485
bi-directional serial ports

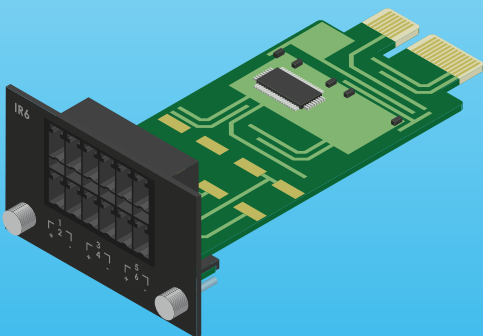

CARD-IR6

Infrared emitter card
6 x IR outputs, routable, stackable

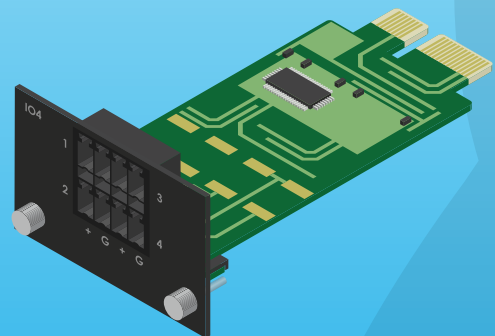

CARD-IO4

Multi-purpose input/output card
4 x configurable I/O - dry contact, voltage,
resistance, LED output

*3D rendering. Final product may change slightly.

Solo + Nano

Modular & Expandable IP Control Systems

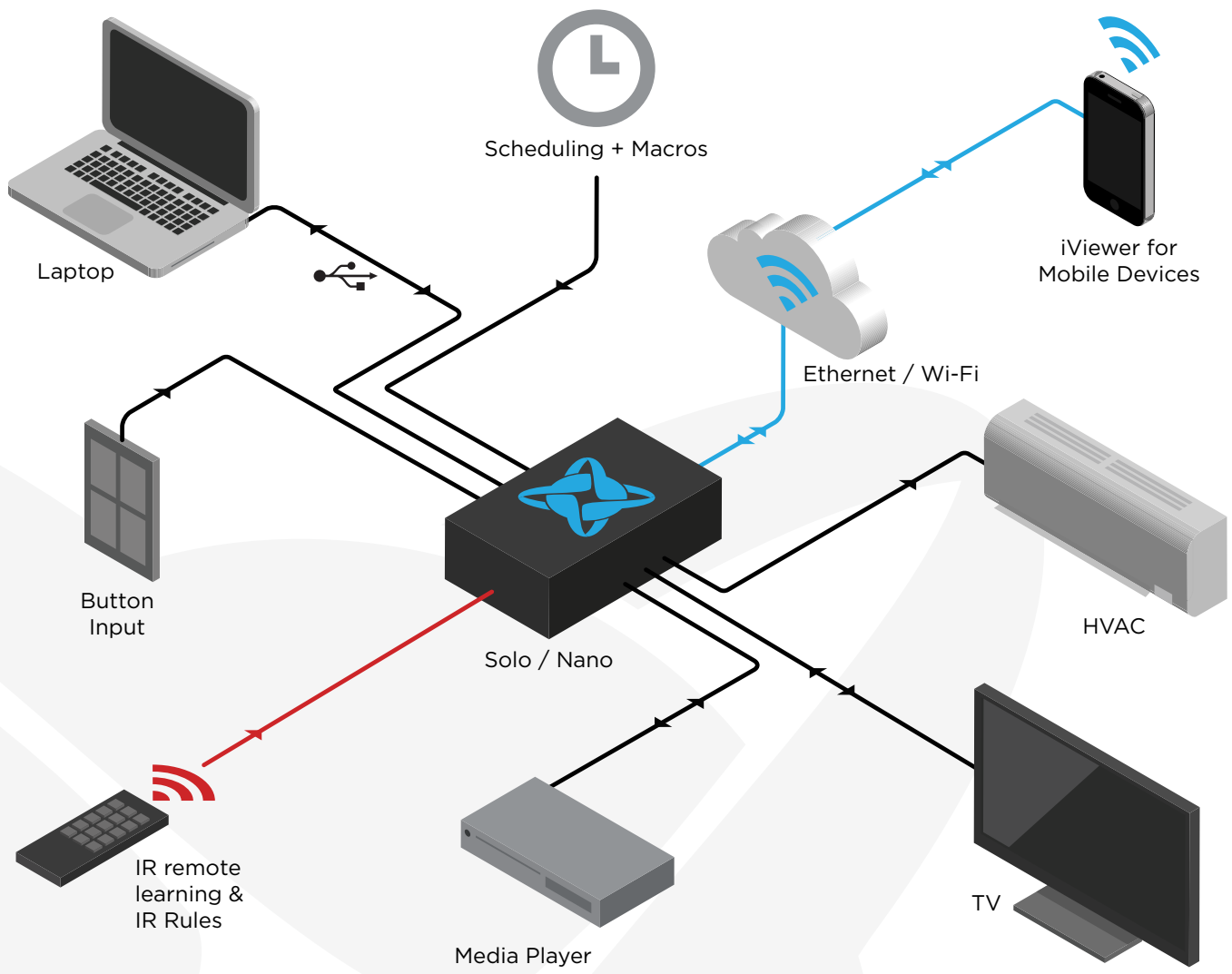

NANO-WIFI with 2 NANO-E expanders connected

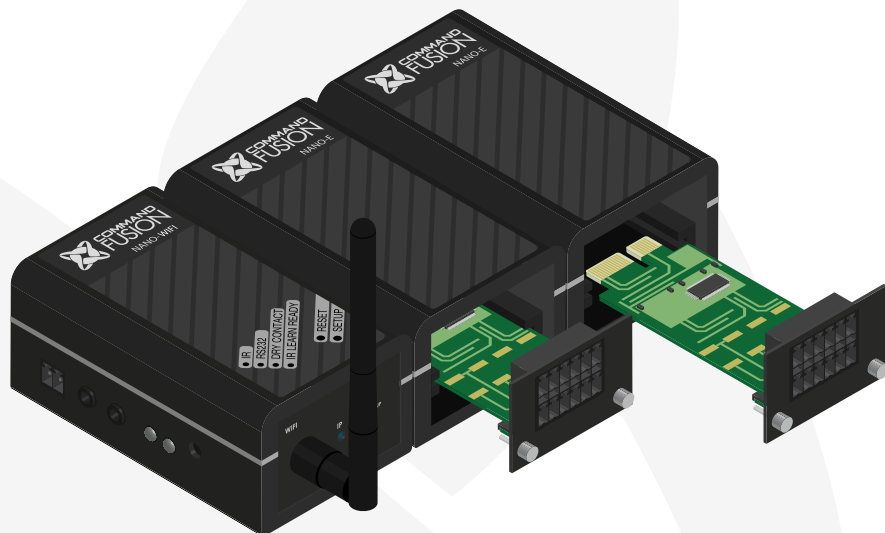

iViewer & iViewer Lite

Supported Platforms



iOS (iPhone, iPad, iPod Touch) 4.3 and later

GENYMOTION^{OO}



Android 2.3 and later
Windows, Mac & Linux via emulation



Fully Customisable User Interface

- Customise using guiDesigner drag-and-drop software (Windows only).
- Unlimited pages and subpages with licence (single page is free).
- Support for independent portrait and landscape orientations to show different UI when rotating the device.
- Buttons, sliders, gauges, dynamic images, video streaming (MJPEG, H.264, MPEG-4), web page embedding, dynamic scrolling lists, text objects, graphics and input fields amongst others.
- Transitions for page flips and subpages.
- Audio file playback triggered via events.
- Gesture engine to take full advantage of multi-touch, including multiple finger touches, swipes, pinch/zoom and rotation gestures.

Communication & Control

- Simultaneously control unlimited Ethernet devices directly from the mobile device, no other hardware required.
- Not restricted to talk to specific hardware, works with any Ethernet controllable system.
- Available communication methods:
 - TCP Server/Client
 - UDP Unicast/Broadcast/Multicast
 - HTTP/HTTPS
- Highly configurable communication sockets including heartbeats, startup events and queuing.
- Macros with customisable delays.
- Built in remote debugger tool to show status of system connections, incoming data logs, GUI object states, etc. All done via web browser connected to the device running iViewer. Supported web browsers are Chrome and Safari (Windows, Mac).

Feedback Processing

- Powerful feedback processing engine using regular expressions (regex).
- Capture data from any Ethernet device and process it for display as text, button states, slider levels, etc.
- Loopback communications to allow logic processing locally on the mobile device - great for programming UI interaction events and demonstrations.
- Highly flexible data processing without being forced to use scripting languages.

JavaScript API

- Use the power of JavaScript to add logic scripting to your project.
- Scriptable communications with external systems allows for advanced communication handling.
- Powerful logic and string manipulation functions built in.
- Re-use modular scripts for common device integration.
- Gather data from built in sensors such as GPS, accelerometer and gyro and perform actions via scripts.
- Manipulate GUI objects for advanced animations and GUI object states.
- Automatic service discovery and publishing via Bonjour.
- Advanced event handling such as video load state changes, incoming data changes, UI interactions, sensor changes, etc.

OEM Branding

- Service offering available to fully rebrand the app.
- Release as a new app on the app store, with customised icon, description, default user interface, etc.
- Contact us for implementation and pricing details on this service.

CommandFusion iViewer allows full two way remote control of any hardware or software capable of TCP/IP or UDP communications, directly from iOS or Android devices.

iViewer works seamlessly with our own CommandFusion hardware, as well as other systems such as Crestron, AMX, Control4, Global Caché, and any other product that can be accessed over ethernet or WiFi.

Our powerful iViewer automation engine lets you create beautiful, dynamic and animated users interfaces. Using our guiDesigner software, you have full control over how each page looks and interacts. You can fully customize the layouts, themes and interactions. Easily program animations and page transitions. Create commands and macros assigned to on-screen objects. assign actions to user gestures, and much more.

Advanced data processing is possible via our powerful data analysis engine, allowing you to automatically take action upon events received from the remote devices. In depth networking includes TCP, UDP with broadcast and multicast support.



For even more control, iViewer can be driven by JavaScript code. Our extensive programming interface allows controlling each and every aspect of the user interface and network communications. Powerful JavaScript modules provided by CommandFusion and third parties allow for unlimited extensibility and reusability.

For more information including documentation and quick start guides, see our website: <http://www.commandfusion.com/iviewer.html>

DIN-MOD4

DIN Rail 4-slot modular controller



The DIN-MOD4 is a modular controller with 4 slots. It can be further expanded via the CFLink BUS.

- CFLink BUS device with independent processor and memory
- 1 x RS232 programming or RS232 port
- 1 x dry-contact input port
- 4 slots, fits any CF module
- MicroSD slot for memory expansion
- Memory used for storage of IR Files and event triggering

CommandFusion (CF) products are designed to simplify control system programming without compromising on functionality. CF hardware integrates easily with its mobile control apps and allows for sophisticated GUI control over any third party device.

Direct control via user interfaces, event-driven automation as well as scheduling (using the LANBridge) are all easily programmed with the free Systems Commander software. Both CF software and hardware control protocol are fully published, allowing for CF devices to be seamlessly integrated with any other software or hardware.

The CFLink BUS supports more than 100 devices, which already makes for an extremely scalable solution. Further expansion is possible via ethernet, allowing for indefinite expansion.

CFLink

The CFLink BUS is a 5-pin 9-30 volts DC powered bus with an isolated RS485 communication line. Every CFLink device has its own processor and memory, which allows for distributed processing, simplified programming as well as eliminating the reliance on a single processor.

CFLink Cabling

Without taking into account of power loss, standard Cat6 cabling can be used with distances over 1,000m (3,000ft) for individual runs. Cabling topology can be daisy-chain, star or a mix of both.

CONNECTIVITY	
CFLink	2 looped detachable 5-pin 3.81mm terminal block for CFLink BUS
RS232/PGM	9-pin DB9 male port for RS232 control of devices; or programming mode which allows both programming and external control of the CFLink BUS devices via RS232
Input	Detachable, 2-pin 3.50mm terminal block for dry contact input
MicroSD slot	Spring-loaded memory expansion slot
Slot 1-4	Slots for modules to be installed in (sold separately, shipped with 4 blank modules)
POWER	
CFLink Power	9-30V DC, 24V DC regulated recommended (power supply is not included)
Power Consumption	250mW maximum
FRONT PANEL	
Power Indicator	Blue LED indicates power status
CFLink Fault LED	Red LED indicates error on CFLink BUS
CFLink Activity LED	Yellow LED indicates CFLink BUS traffic
Setup Button	Used to start changing the CFLink ID of the unit and also factory reset
Up/Down buttons	Up/Down buttons used to change the CFLink ID when in setup mode
Reset Button	Reset button restarts the processor
COM Port Button	COM port button used to select program or RS232 mode for on-board RS232 port
Program Indicator	Yellow LED indicates on-board RS232 port is used for programming or control of CFLink BUS
RS232 Indicator	Yellow LED indicates on-board RS232 port is used for control of external RS232 devices
PHYSICAL	
Enclosure	Polycarbonate with dark grey matte finish; occupies 12 DIN module spaces (216mm)
Height	90mm (3.54in)
Width	216mm (8.50in)
Depth	60mm (2.36in)
Weight	0.57kg (1.26lbs), Shipping 0.9kg (1.98lbs)
Temperature	5°C to 45°C (41°F to 113°F)
Humidity	20% to 85% RH, non-condensing
Certification	FCC, CE, C-Tick
WARRANTY	
Warranty	5 years limited warranty

MOD4

Rackmountable 4-slot modular controller



The MOD4 is a modular controller with 4 slots. It can be further expanded via the CFLink BUS.

- CFLink BUS device with independent processor and memory
- 1 x RS232 programming or RS232 port
- 1 x dry-contact input port
- 4 slots, fits any CF module
- MicroSD slot for memory expansion
- Memory used for storage of IR Files and event triggering

CONNECTIVITY	
CFLink	2 looped detachable 5-pin 3.81mm terminal block for CFLink BUS
RS232/PGM	9-pin DB9 male port for RS232 control of devices; or programming mode which allows both programming and external control of the CFLink BUS devices via RS232
Input	Detachable, 2-pin 3.50mm terminal block for dry contact input
MicroSD slot	Spring-loaded memory expansion slot
Slot 1-4	Slots for modules to be installed in (sold separately, shipped with 4 blank modules)
POWER	
CFLink Power	9-30V DC, 24V DC regulated recommended (power supply is not included)
Power Consumption	250mW maximum
FRONT PANEL	
Power Indicator	Blue LED indicates power status
CFLink Fault LED	Red LED indicates error on CFLink BUS
CFLink Activity LED	Yellow LED indicates CFLink BUS traffic
Setup Button	Used to start changing the CFLink ID of the unit and also factory reset
Up/Down buttons	Up/Down buttons used to change the CFLink ID when in setup mode
Reset Button	Reset button restarts the processor
COM Port Button	COM port button used to select program or RS232 mode for on-board RS232 port
Program Indicator	Yellow LED indicates on-board RS232 port is used for programming or control of CFLink BUS
RS232 Indicator	Yellow LED indicates on-board RS232 port is used for control of external RS232 devices
PHYSICAL	
Enclosure	Polycarbonate with dark grey matte finish; occupies 12 DIN module spaces (216mm)
Height	90mm (3.54in)
Width	216mm (8.50in)
Depth	60mm (2.36in)
Weight	0.57kg (1.26lbs), Shipping 0.9kg (1.98lbs)
Temperature	5°C to 45°C (41°F to 113°F)
Humidity	20% to 85% RH, non-condensing
Certification	FCC, CE, C-Tick
WARRANTY	
Warranty	5 years limited warranty

CommandFusion (CF) products are designed to simplify control system programming without compromising on functionality. CF hardware integrates easily with its mobile control apps and allows for sophisticated GUI control over any third party device.

Direct control via user interfaces, event-driven automation as well as scheduling (using the LANBridge) are all easily programmed with the free System Commander software. Both CF software and hardware control protocols are fully published, allowing for CF devices to be seamlessly integrated with any other software or hardware.

The CFLink BUS supports more than 100 devices, which already makes for an extremely scalable solution. Further expansion is possible via ethernet, allowing for indefinite expansion.

CFLink

The CFLink BUS is a 5-pin 9-30 volts DC powered bus with an isolated RS485 communication line. Every CFLink device has its own processor and memory, which allows for distributed processing, simplified programming as well as eliminating the reliance on a single processor.

CFLink Cabling

Without taking into account of power loss, standard Cat6 cabling can be used with distances over 1,000m (3,000ft) for individual runs. Cabling topology can be daisy-chain, star or a mix of both.

Available Modules



MOD-HRY2
Relay module
2 x 250VAC 15A latching (polarized) relays



MOD-RY4
Relay module
4 x 250VAC 5A non-latching normally-open relays



MOD-LRY8
Relay module
8 x 30VDC 1A latching (polarized) relays



MOD-SSRY4
Solid-state relay module
4 x 250VAC 2A non-latching normally-open solid-state relays



MOD-IR8
Infrared module
8 x IR outputs



MOD-IO8
Input/Output module
8 x configurable I/O - dry contact, voltage, resistance, LED output



MOD-COM4
Serial port module
2-4 x configurable RS232/422/485 bi-directional serial ports

MOD-HRY2

2-channel 15A latching relay module



The MOD-HRY2 is a 2-channel 15A latching relay module that fits into any modular controller.

- 2 x 250 volts AC 15A latching (polarized) relays

Overview

The HRY2 module features 2 high voltage, high-amperage (250V AC, 15A) relay ports, and comes with on-board screw terminals for secure connections to external relay controlled high voltage devices. Plug it into a modular controller to add relay control ports to your system.

Power On States

Each relay port can be configured to be in open, closed or resume last state on power up. And because the relays are latching (polarized), they will stay in their open or closed state even when power is lost.

Extended Functionality

Most relay control systems out there allow you to set relays on or off, and require complex programming on a control processor to perform anything else. Our relay control protocol includes additional functionality such as a simple toggle command (so that you don't have to keep track of the relay state for basic toggle actions) and a pulsing command to pulse the relay closed for a time period, then opening again (of course, the time period is customisable as part of the protocol). Relay control has never been so easy.

CONNECTIVITY	
Module Connector	24-pin connector to connect to modular controller unit
Relay 1-2	1 set of captive screw terminals consisting of 2 relay channels Wire range: 18-8 AWG Relay Rating: 250V AC 15A
TOP PANEL	
Clip	Secures and releases the module from the modular controller unit
Label	Model and serial number information.
POWER	
Power Consumption	Power usage 500mW maximum, powered by modular controller DIN-MOD4 or MOD4 (not included)
PHYSICAL	
Enclosure	Polycarbonate with dark grey matte finish
Height	32.8mm (1.29in)
Width	40mm (1.57in)
Depth	68mm (2.68in)
Weight	0.07kg (0.15lbs), Shipping 0.2kg (0.44lbs)
ENVIRONMENTAL & REGULATORY	
Temperature	5°C to 45°C (41°F to 113°F)
Humidity	20% to 85% RH, non-condensing
Certification	FCC, CE, C-Tick
WARRANTY	
Warranty	5 years limited warranty

MOD-RY4

4-channel 5A relay module



The MOD-RY4 is a 4-channel 5A relay module that fits into any modular controller.

- 4 x 250 volts AC 5A non-latching normally-open relays

Overview

The RY4 module features 4 high voltage (250V AC, 5A) relay ports, and comes with detachable screw terminal blocks for secure connections to external relay-controlled devices. Plug it into a modular controller to add relay control ports to your system.

Power On States

Each relay port can be configured to be in open, closed or resume last state on power up. Using the resume option, they will return to their open or closed state after a power loss.

Extended Functionality

Most relay control systems out there allow you to set relays on or off, and require complex programming on a control processor to perform anything else. Our relay control protocol includes additional functionality such as a simple toggle command (so that you don't have to keep track of the relay state for basic toggle actions) and a pulsing command to pulse the relay closed for a time period, then opening again (of course, the time period is customisable as part of the protocol). Relay control has never been so easy.

CONNECTIVITY	
Module Connector	24-pin connector to connect to modular controller unit
Relay 1-4	4 sets of detachable 3-pin screw terminal blocks (included) consisting of 4 normally-open relay channels Wire range: 28-14 AWG Relay Rating: 250V AC 5A
TOP PANEL	
Clip	Secures and releases the module from the modular controller unit
Label	Model and serial number information.
POWER	
Power Consumption	Power usage 500mW maximum, powered by modular controller DIN-MOD4 or MOD4 (not included)
PHYSICAL	
Enclosure	Polycarbonate with dark grey matte finish
Height	32.8mm (1.29in)
Width	40mm (1.57in)
Depth	68mm (2.68in)
Weight	0.07kg (0.15lbs), Shipping 0.2kg (0.44lbs)
ENVIRONMENTAL & REGULATORY	
Temperature	5°C to 45°C (41°F to 113°F)
Humidity	20% to 85% RH, non-condensing
Certification	FCC, CE, C-Tick
WARRANTY	
Warranty	5 years limited warranty

MOD-SSRY4

4-channel 2A solid-state module



The MOD-SSRY4 is a 4 channel 2A solid-state relay module that fits into any modular controller.

- 4 x 250 volts AC 2A non-latching normally-open solid-state relays

CONNECTIVITY

Module Connector	24-pin connector to connect to modular controller unit
Relay 1-4	4 sets of detachable 3-pin screw terminal blocks (included) consisting of 4 normally-open relay channels Wire range: 28-14 AWG Relay Rating: 250V AC 2A

TOP PANEL

Clip	Secures and releases the module from the modular controller unit
Label	Model and serial number information.

POWER

Power Consumption	Power usage 500mW maximum, powered by modular controller DIN-MOD4 or MOD4 (not included)
--------------------------	--

PHYSICAL

Enclosure	Polycarbonate with dark grey matte finish
Height	32.8mm (1.29in)
Width	40mm (1.57in)
Depth	68mm (2.68in)
Weight	0.07kg (0.15lbs), Shipping 0.2kg (0.44lbs)

ENVIRONMENTAL & REGULATORY

Temperature	5°C to 45°C (41°F to 113°F)
Humidity	20% to 85% RH, non-condensing
Certification	FCC, CE, C-Tick

WARRANTY

Warranty	5 years limited warranty
-----------------	--------------------------

Overview

The SSRY4 module features 4 high voltage (250V AC, 2A) solid-state relay ports, and comes with detachable screw terminal blocks for secure connections to external relay-controlled high-voltage devices. Plug it into a modular controller to add relay control ports to your system. The benefit of solid-state relays are their extremely low noise (almost silent) switching, typical 10x faster switching, very much longer lifetime and more reliable (no moving parts).

Power On States

Each relay port can be configured to be in open, closed or resume last state on power up. Using the resume option, they will return to their open or closed state after a power loss.

Extended Functionality

Most relay control systems out there allow you to set relays on or off, and require complex programming on a control processor to perform anything else. Our relay control protocol includes additional functionality such as a simple toggle command (so that you don't have to keep track of the relay state for basic toggle actions) and a pulsing command to pulse the relay closed for a time period, then opening again (of course, the time period is customisable as part of the protocol). Relay control has never been so easy.

MOD-LRY8

8-channel 1A latching relay module



The MOD-LRY8 is an 8-channel latching relay module that fits into any modular controller.

- 8 x 30 volts DC 1A latching (polarized) relays

CONNECTIVITY	
Module Connector	24-pin connector to connect to modular controller unit
Relay 1-8	4 x detachable 4-pin 3.50mm terminal block consisting of 8 channels of relay ports. Wire range: 24-16 AWG Relay Rating: 30V DC 1A
TOP PANEL	
Clip	Secures and releases the module from the modular controller unit
Label	Model and serial number information.
POWER	
Power Consumption	Power usage 600mW maximum, powered by modular controller DIN-MOD4 or MOD4 (not included)
PHYSICAL	
Enclosure	Polycarbonate with dark grey matte finish
Height	32.8mm (1.29in)
Width	40mm (1.57in)
Depth	68mm (2.68in)
Weight	0.08kg (0.18lbs), Shipping 0.2kg (0.44lbs)
ENVIRONMENTAL & REGULATORY	
Temperature	5°C to 45°C (41°F to 113°F)
Humidity	20% to 85% RH, non-condensing
Certification	FCC, CE, C-Tick
WARRANTY	
Warranty	5 years limited warranty

Overview

The LRY8 module features 8 low voltage (30V DC, 1A) relay ports, and comes with spring terminals for quick and easy, yet secure connections to external relay-controlled devices. Plug it into a modular controller to add relay control ports to your system.

Power On States

Each relay port can be configured to be in open, closed or resume last state on power up. And because the relays are latching (polarized), they will stay in their open or closed state even when power is lost.

Extended Functionality

Most relay control systems out there allow you to set relays on or off, and require complex programming on a control processor to perform anything else. Our relay control protocol includes additional functionality such as a simple toggle command (so that you don't have to keep track of the relay state for basic toggle actions) and a pulsing command to pulse the relay closed for a time period, then opening again (of course, the time period is customisable as part of the protocol). Relay control has never been so easy.

MOD-IO8

8-channel I/O module



The MOD-IO8 is an 8 channel I/O module that fits into any modular controller.

- 8 channels of I/O programmable to be either digital input, analog voltage or resistance input read or LED output

CONNECTIVITY	
Module Connector	24-pin connector to connect to modular controller unit
I/O 1-8	2 detachable 4-pin 3.5mm spring terminal blocks for GPIO modes: <ul style="list-style-type: none"> - Digital input mode for dry contact inputs - Analog input mode for: 0-10 Volts DC read (0.1 V increments), 0-10k Ohms resistance read (100 Ohm increments), Voltage sensing input (adjustable thresholds), video sensing input - Digital output mode for: LED output (5V DC, 1mA max), External relay control (separate relay power supply required)
TOP PANEL	
Clip	Secures and releases the module from the modular controller unit
Label	Model and serial number information.
POWER	
Power Consumption	Power usage 500mW maximum, powered by modular controller DIN-MOD4 or MOD4 (not included)
PHYSICAL	
Enclosure	Polycarbonate with dark grey matte finish
Height	32.8mm (1.29in)
Width	40mm (1.57in)
Depth	68mm (2.68in)
Weight	0.05kg (0.11lbs), Shipping 0.2kg (0.44lbs)
ENVIRONMENTAL & REGULATORY	
Temperature	5°C to 45°C (41°F to 113°F)
Humidity	20% to 85% RH, non-condensing
Certification	FCC, CE, C-Tick
WARRANTY	
Warranty	5 years limited warranty

Overview

The IO8 module features 8 user configurable I/O ports, and comes with spring terminals for quick and easy, yet secure connections to external inputs/sensors/outputs. Plug it into a modular controller to add I/O ports to your system.

Notifications

The IO8 can be setup to send notifications based on a configurable minimum change level per port. Notifications can be sent as a broadcast to all CFLink devices, to specific CFLink IDs or both.

Dry Contact Input

When a port is configured as a dry contact input, it will give a reading on it's open/closed state. Used for button inputs, sensor triggers, etc.

Resistance Reading Input

When a port is configured as a resistance reading input, it can measure input ranging from 0 Ohm to 10,000 Ohm, in 100 Ohm increments. Used for light sensors, temperature sensors, etc.

Voltage Reading Input

When a port is configured as a voltage reading input, it can measure input ranging from 0V DC to 10V DC, in 0.1 Volt increments. Used for battery level sensors, video signal sensors, etc.

LED Output

When a port is configured as an LED output, it can be set to on or off state, 3.3V DC 1mA max.

MOD-COM4

4-channel COM module



The MOD-COM4 is a 2 to 4 channel COM module that fits into any modular controller.

- 2 to 4 channels of RS232, RS422 or RS485 serial communication ports

Overview

The COM4 module features 2-4 user configurable serial ports, and comes with spring terminals for quick and easy, yet secure connections to control external serial devices. Plug it into a modular controller to add serial port control to your system.

Serial Ports

The number of available serial ports depends on the modes they are configured in. For instance, 4 separate ports can be defined for RS232 without flow control. But only 2 ports can be configured if both set to RS485.

Passthrough Modes

Any device on the CFLink network, including the COM4 module, can be configured to passthrough their incoming and outgoing data to the LAN Bridge, for direct Ethernet access (TCP or UDP).

Notifications

The COM4 can be setup to send notifications of incoming data per port. Notifications can be sent as a broadcast to all CFLink devices, to specific CFLink IDs or both.

CONNECTIVITY	
Module Connector	24-pin connector to connect to modular controller unit
COM 1-4	2 x detachable 6-pin 3.50mm terminal block consisting of 2 to 4 channels of serial ports. Wire range: 24-16AWG
TOP PANEL	
Clip	Secures and releases the module from the modular controller unit
Label	Model and serial number information.
POWER	
Power Consumption	Power usage 200mW maximum, powered by modular controller DIN-MOD4 or MOD4 (not included)
PHYSICAL	
Enclosure	Polycarbonate with dark grey matte finish
Height	32.8mm (1.29in)
Width	40mm (1.57in)
Depth	68mm (2.68in)
Weight	0.05kg (0.11lbs), Shipping 0.2kg (0.44lbs)
ENVIRONMENTAL & REGULATORY	
Temperature	5°C to 45°C (41°F to 113°F)
Humidity	20% to 85% RH, non-condensing
Certification	FCC, CE, C-Tick
WARRANTY	
Warranty	5 years limited warranty

MOD-IR8

8-channel IR module



The MOD-IR8 is an 8 channel infra-red module that fits into any modular controller.

- 8 channels of IR outputs for wired emitters
- On board IR library with over 500,000 non-unique codes

Overview

The IR8 module features 8 stackable IR outputs, and comes with spring terminals for quick and easy, yet secure connections to IR emitters. 8 x single-headed IR emitters are included. Plug it into a modular controller to add IR ports to your system.

Advanced IR Control

All modular controllers are capable of advanced IR functionality such as smooth IR repeating, on-board IR database and storing IR codes in on-board memory. The IR8 module can be used in any modular controller to take advantage of all this functionality.

Stackable IR outputs

Stackable IR outputs allow you to control more than one device from a single port. Either by using multi-headed emitters, or wiring multiple emitters to the same port.

CONNECTIVITY	
Module Connector	24-pin connector to connect to modular controller unit
IR 1-8	4 x detachable 4-pin 3.50mm terminal block consisting of 8 channels of infrared ports. Wire range: 24-16AWG
TOP PANEL	
Clip	Secures and releases the module from the modular controller unit
Label	Model and serial number information.
POWER	
Power Consumption	Power usage 200mW maximum, powered by modular controller DIN-MOD4 or MOD4 (not included)
PHYSICAL	
Enclosure	Polycarbonate with dark grey matte finish
Height	32.8mm (1.29in)
Width	40mm (1.57in)
Depth	68mm (2.68in)
Weight	0.05kg (0.11lbs), Shipping 0.2kg (0.44lbs)
ENVIRONMENTAL & REGULATORY	
Temperature	5°C to 45°C (41°F to 113°F)
Humidity	20% to 85% RH, non-condensing
Certification	FCC, CE, C-Tick
WARRANTY	
Warranty	5 years limited warranty

CF Mini

Miniature integrated controller



The CF Mini is a multi-purpose all-in-one controller specifically designed for single room to mid-size installations.

- CFLink BUS device with independent processor and memory
- 1 x RS232 programming or RS232 port
- 8 x IR outputs for wired emitters, with onboard IR library for over 500,000 non-unique codes
- 4 channels of I/O either as digital input, voltage or resistance input read or LED output
- 4 x 30 volts DC 1A latching relay
- MicroSD slot for memory expansion
- Memory used for storage of IR Files and event triggering

Overview

The CF Mini is a powerful, all-in-one controller. It features 8 x IR outputs, 4 x configurable I/O ports, 4 x 30VDC latching relays and one RS232/Program port.

Featuring a variety of control methods in a single box, the CF Mini is perfect for single room installs such as home theatres and boardrooms, as well as distributed systems such as classrooms.

Combine with LAN Bridge

The CF Mini does not feature an Ethernet port. Instead, the CFLink port is used to expand your system with any other CFLink devices. The LAN Bridge is a perfect companion for the CF Mini, for a very affordable single room solution when controlled by a mobile device such as the Apple iPad.

Rules Engine

All CFLink devices, including the CF Mini, support a powerful rule triggering engine. This allows you to trigger macros to run when a specific event occurs - such as reading a specific value via the I/O ports, or on incoming data via the RS232 port. Using the rules engine, you can setup basic or complex automation actions.

On-board IR Database

All IR emitting devices in the CommandFusion range include an on-board IR database, with over 500,000 IR codes built in.

CONNECTIVITY

CFLink	Detachable 5-pin 3.81mm terminal block for CFLink BUS
COM	6-pin RJ11 female port for RS232 control of devices; or programming mode which allows both programming and external control of the CFLink BUS devices
IR 1-8	4 detachable 4-pin 3.5mm spring terminal blocks for infrared emitters
I/O 1-4	2 detachable 4-pin 3.5mm spring terminal blocks for GPIO modes: <ul style="list-style-type: none"> - Digital input mode for dry contact inputs - Analog input mode for: 0-10 Volts DC read (0.1 V increments), 0-10k Ohms resistance read (100 Ohm increments), Voltage sensing input (adjustable thresholds), video sensing input - Digital output mode for: LED output (5V DC, 1mA max), External relay control (separate relay power supply required)
Relay 1-4	2 detachable 4-pin 3.5mm spring terminal blocks for latching relays; rated 1A 30 volts AC/DC
MicroSD Slot	Spring-loaded memory expansion slot (card not included)

POWER

CFLink Power	9-30V DC, 24V DC regulated recommended (power supply is not included)
Power Consumption	4W maximum

TOP PANEL

Power Indicator	Blue LED indicates power status
CFLink Fault LED	Red LED indicates error on CFLink BUS
CFLink Activity LED	Yellow LED indicates CFLink BUS traffic
Setup Button	Setup button used for factory reset
Reset Button	Reset button restarts the processor
Prog Indicator	Yellow LED indicates RS232 port is used for programming or control of CFLink BUS
RS232 Indicator	Yellow LED indicates RS232 port is used for control of RS232 devices
Status Indicator	Yellow LED indicates status/activity on any of the CF Mini on-board ports (configurable)

PHYSICAL

Enclosure	Polycarbonate with dark grey matte finish
Height	61mm (2.40in)
Width	81.4mm (3.2in)
Depth	76.4mm (3.0in)
Weight	0.22kg (0.49lbs), Shipping 0.4kg (0.88lbs)
Temperature	5°C to 45°C (41°F to 113°F)
Humidity	20% to 85% RH, non-condensing
Certification	FCC, CE, C-Tick

WARRANTY

Warranty	5 years limited warranty
-----------------	--------------------------

LAN Bridge

Ethernet & RS232 CFLink bridge



The LAN Bridge provides an Ethernet interface to all CFLink devices, supporting a variety of Ethernet protocols and communication options.

- CFLink BUS device with independent processor and memory
- 1 x Ethernet socket for wired LAN connectivity
- 1 x RS232 programming or RS232 port
- Realtime clock with scheduling support
- MicroSD slot for memory expansion
- Memory used for storage of IR Files and event triggering

Overview

The LAN Bridge is the Ethernet & RS232 gateway for all devices connected via the CFLink bus. It has many advanced networking features, including the ability to communicate via TCP Server, TCP Client, UDP Unicast and UDP Broadcast, all at the same time.

10 different communication slots can be defined, each with its own configuration of protocol type, port, and other options. A maximum of 25 total TCP socket connections can be shared between each defined slot.

Scheduling

The on-board realtime clock allows the LAN Bridge to be used for scheduling of events, as well as randomised "away mode" events for security reasons. The clock can be configured to sync with a time server to ensure it's automatically updated in regions with Daylight Savings requirements.

CONNECTIVITY

CFLink	Detachable 5-pin 3.81mm terminal block for CFLink BUS
RS232/PGM	6-pin RJ11 female port for RS232 control of devices; or programming mode which allows both programming and external control of the CFLink BUS devices via RS232.
Ethernet	RJ45 female port for Ethernet connectivity, with two LED status lights for data transmission and connectivity status.
MicroSD slot	Spring-loaded memory expansion slot

POWER

CFLink Power	9-30V DC, 24V DC regulated recommended (power supply is not included)
Power Consumption	2W maximum

TOP PANEL

Power Indicator	Blue LED indicates power status
CFLink Fault LED	Red LED indicates error on CFLink BUS
CFLink Activity LED	Yellow LED indicates CFLink BUS traffic
Setup Button	Setup button used to select program or RS232 mode for RS232 port and also factory reset
Reset Button	Reset button restarts the processor
Prog Indicator	Yellow LED indicates RS232 port is used for programming or control of CFLink BUS
RS232 Indicator	Yellow LED indicates RS232 port is used for control of RS232 devices
Status Indicator	Yellow LED indicates data being sent/received via the RS232 port

PHYSICAL

Enclosure	Polycarbonate with dark grey matte finish
Height	41mm (1.61in)
Width	81.4mm (3.2in)
Depth	76.4mm (3.0in)
Weight	0.13kg (0.29lbs), Shipping 0.3kg (0.66lbs)
Temperature	5°C to 45°C (41°F to 113°F)
Humidity	20% to 85% RH, non-condensing
Certification	FCC, CE, C-Tick

WARRANTY

Warranty	5 years limited warranty
-----------------	--------------------------

SW16

16-channel button interface



The SW16 is a 16-channel button interface for custom-made button panels.

- CFLink BUS device with independent processor and memory
- 16 x digital inputs for buttons
- 16 x dimmable LED outputs for indicators
- 4 x dimmable LED outputs for backlight

Overview

The SW16 is used to interface physical buttons to the CFLink network. With 16 x Dry contact inputs, you can connect up to 16 momentary or toggle switches to control your automation system. The 16 channels of dimmable LED outputs allow you to show feedback states for the buttons, and 4 dimmable backlight LED outputs can be used to backlight your keypad if required.

Dimmable LED Outputs

The 16 dimmable LED outputs and 4 dimmable backlight LED outputs can be controlled via the CFLink protocol. This allows you to not only turn these LEDs on and off, but you can set the dimming level of the individual outputs, in 100 steps. There are also commands to ramp between levels, blink the LED (set number of times or continuously) and dim up/down in a loop. This means you can show all sorts of feedback states via these LED outputs. You could even use 3 channels of the LED outputs to drive a single RGB LED for multi-color feedback states.

Custom Button Panels

Although you could use any off the shelf button panel and wire the buttons up to the SW16, you could also create your own custom button panels to suit any task. Put a few buttons together on a wall plate material of your choosing, and create physical interfaces for industrial automation tasks.

CONNECTIVITY	
CFLink	Detachable 5-pin 3.81mm terminal block for CFLink BUS
40 pin connector	40-pin ribbon cable (included) 16 digital inputs (pins 1-16) referenced to ground 16 dimmable LED outputs 4 dimmable backlight LED outputs 3.3V / 5V header for selecting LED voltages
MicroSD Slot	Spring-loaded memory expansion slot (card not included)
POWER	
CFLink Power	9-30V DC, 24V DC regulated recommended (power supply is not included)
Power Consumption	2W maximum
TOP PANEL	
Power Indicator	Blue LED indicates power status
CFLink Fault LED	Red LED indicates error on CFLink BUS
CFLink Activity LED	Yellow LED indicates CFLink BUS traffic
Setup Button	Setup button used for factory reset
Reset Button	Reset button restarts the processor
Input Indicator	Yellow LED indicates one of the dry contact inputs is closed
LED Indicator	Yellow LED indicates one of the dimmable LED outputs is on
BLight Indicator	Yellow LED indicates one of the dimmable backlight LED outputs is on
PHYSICAL	
Enclosure	Polycarbonate with dark grey matte finish
Height	31.5mm (1.24in)
Width	81.4mm (3.2in)
Depth	76.4mm (3.0in)
Weight	0.11kg (0.24lbs), Shipping 0.3kg (0.66lbs)
Temperature	5°C to 45°C (41°F to 113°F)
Humidity	20% to 85% RH, non-condensing
Certification	FCC, CE, C-Tick
WARRANTY	
Warranty	5 years limited warranty

IR Blaster

IR blaster and receiver



The IR Blaster can flood a room with IR and can be used standalone to convert any remote into a universal remote, with macro capabilities.

- CFLink BUS device with independent processor with on-board IR library with over 500,000 non-unique codes
- On-board IR blaster with over 270° coverage
- On-board IR receiver
- Independent second IR port for wired emitter
- Independent second wired IR receiver port
- MicroSD slot for memory expansion
- Memory used for storage of IR Files and event triggering

Overview

The IR Blaster is a multi-functional IR control device. Featuring a 270° IR blaster on-board, as well as an additional 3.5mm jack for an IR emitter, you get the best of both IR control worlds - room flooding and directional control.

IR Receiver

The on-board IR receiver and additional 3.5mm jack for an IR receiver (not included), provide a way use the incoming IR signal to trigger macros via the Rules Engine. So you can use any IR remote control to perform actions throughout your automation system, such as control your lights or security system.

IR Database & Storage

All IR emitting devices in the CommandFusion range include an on-board IR database, with over 500,000 IR codes built in. If the device you want to control doesn't exist in the database, simply use our IR Learner to learn the IR codes and create an IR file ready for storage directly in the IR Blaster's on-board memory.

CONNECTIVITY	
CFLink	Detachable 5-pin 3.81mm terminal block for CFLink BUS
IR Out	3.5mm mini phone jack for external IR emitter (included)
IR In	3.5mm mini phone jack for external IR receiver (not included)
MicroSD slot	Spring-loaded memory expansion slot
FRONT PANEL	
IR Blaster	High-powered infrared blaster built-in, with over 270° coverage
IR Receiver	On-board infrared receiver, front facing
POWER	
CFLink Power	9-30V DC, 24V DC regulated recommended (power supply is not included)
Power Consumption	1W maximum
TOP PANEL	
Power Indicator	Blue LED indicates power status
CFLink Fault LED	Red LED indicates error on CFLink BUS
CFLink Activity LED	Yellow LED indicates CFLink BUS traffic
Setup Button	Setup button used for factory reset
Reset Button	Reset button restarts the processor
Blast Indicator	Yellow LED indicates IR signal being sent via on-board Blaster output
Out 2 Indicator	Yellow LED indicates IR signal being sent via 3.5mm IR output connector
Recv Indicator	Yellow LED indicates IR signal being received via either the on-board IR receiver or the 3.5mm input connector
PHYSICAL	
Enclosure	Polycarbonate with dark grey matte finish
Height	32mm (1.26in)
Width	81.4mm (3.2in)
Depth	76.4mm (3.0in)
Weight	0.11kg (0.24lbs), Shipping 0.3kg (0.66lbs)
Temperature	5°C to 45°C (41°F to 113°F)
Humidity	20% to 85% RH, non-condensing
Certification	FCC, CE, C-Tick
WARRANTY	
Warranty	5 years limited warranty

IR Learner

USB Infrared Learner



The IR Learner is a tiny USB device capable of learning infrared remotes from 30kHz to 455kHz. It has also been engineered to handle long and complex infrared codes typically found in higher end split system air conditioners.

- IR learning from 30kHz to 455kHz
- Able to learn long IR codes
- Onboard IR library with over 500,000 non-unique codes
- Onboard IR blaster with over 120° coverage for testing

Overview

The only IR Learner you will ever need. About the size of a matchbox, the IR Learner is capable of learning any IR code and then testing it for accuracy via the on-board blaster output. The front IR window is used for learning, with the rear IR window housing the blaster output.

CONNECTIVITY & POWER	
Mini USB	Mini USB female connector (Type B). USB cable included.
FRONT PANEL	
IR Receiver	On-board infrared receiver, front facing, capable of learning 30kHz to 455kHz IR signals
REAR PANEL COMPONENTS	
IR Blaster	High-powered IR Blaster on-board, with over 120° coverage
TOP PANEL	
Power Indicator	Blue LED indicates power status
Activity Indicator	Yellow LED indicates IR signal being sent or received
Ready Indicator	Green LED indicates IR learning is completed
Reset Button	Reset button used to restart the device
PHYSICAL	
Enclosure	Polycarbonate with dark grey matte finish
Height	17mm (0.67in)
Width	60mm (2.36in)
Depth	44mm (1.73in)
Weight	0.04kg (0.09lbs), Shipping 0.2kg (0.44lbs)
Temperature	5°C to 45°C (41°F to 113°F)
Humidity	20% to 85% RH, non-condensing
Certification	FCC, CE, C-Tick
WARRANTY	
Warranty	5 years limited warranty

IRE-Slim

Ultraslim Infrared Emitter



CONNECTIVITY

Connector	3.5mm mini phono jack (easily removed for devices requiring bare wire connections, such as our MOD-IR8 module)
------------------	--

In The Box

IR Emitter	x 1
3M® sticker pads	x 1 pre-applied, x 2 extras
IR Shield	x 1 with 3M® adhesive pre-applied

PHYSICAL

Emitter Head	12.9mm x 8mm x 2.4mm
Cable Length	2m
Wire Gauges	AWG22 (1m, phono jack end), AWG28 (1m, emitter end)
3M® Adhesive Pads	12.9mm x 8mm x 0.5mm
IR Shield (with 3M® adhesive)	35mm x 20mm x 1mm (flat area), 3.6mm max thickness

WARRANTY

Warranty	5 years limited warranty
-----------------	--------------------------

The ultimate IR probe - IRE-Slim is a tiny, inconspicuous, subtle and unobtrusive IR emitter without compromise.

- Only 2.4mm thin
- Thicker gauge figure 8 cable where it's hidden - easy to extend
- Ultrathin cable where it's visible
- Additional adhesive pads and IR shield included

Overview

The IRE-Slim emitter is an infrared probe designed by custom integrators, for custom integrators. Featuring the thinnest emitting head, slimmest 3.5mm phono jack, smoothly designed wire gauge step down join and useful accessories.

Easy to Extend and Install

The wire gauge (thickness of wire) and figure 8 insulation allows it to be easily extended for longer cable runs. Every aspect of the cable has been designed and moulded to be as thin as possible without compromising on strength. The wire join is designed to be snag-free and the wire leading up to the emitter is ultra-thin to be as hidden as possible.

Added Accessories

Each IR emitter is shipped with two additional high quality 3M® sticker pads for reuse, as well as a moulded shield with 3M adhesive to cover the emitter and prevent external IR control or interference for the most reliable IR control possible.

RACKIT

Rack-mount kit



Rack-mount kit for 2 x MOD4 controllers.

- **1RU (rack unit) high, full 19" rack width.**
- **Locking tabs and cable management.**

PHYSICAL

Material	Steel with dark grey matte finish
Height	43mm (1.69in), 1RU
Width	482.6mm (19in)
Width (internal shelf)	441mm (17.36in)
Depth	458mm (18in)
Weight	1.6kg (3.52lbs), Shipping 2.0kg (4.41lbs)

WARRANTY

Warranty	5 years limited warranty
-----------------	--------------------------

Overview

The RACKIT allows for one or two MOD4's to be rack mounted in a standard 19" rack, taking up just 1RU height, great for those installations where rack space is at a premium. The RACKIT incorporates a number of cable management and installation features to ensure an easy, high quality installation.

Cable Management

Utilise the cable management features of the RACKIT to achieve a quality installation. Cable management features includes:

- Tie down locations to utilise cable ties and velcro strips
- Various cutouts to allow for flexible cable routing

Ease of Installation and Maintenance

The RACKIT was designed by integrators to allow for maximum ease of installation and access for maintenance.

- Spring loaded locking tabs
- Secondary screw locations for security
- Guides to ensure neat installation
- Sliding action of MOD4 with guide tabs to ensure access to modules is easy, without risk of connector damage or the unit falling out of the RACKIT

Residential Application Diagram - Whole House



- Ethernet
- CFLink
- Relays
- Input/Output
- Serial
- Button Inputs / LED Outputs
- IR Emitter
- IR Blaster
- DALI

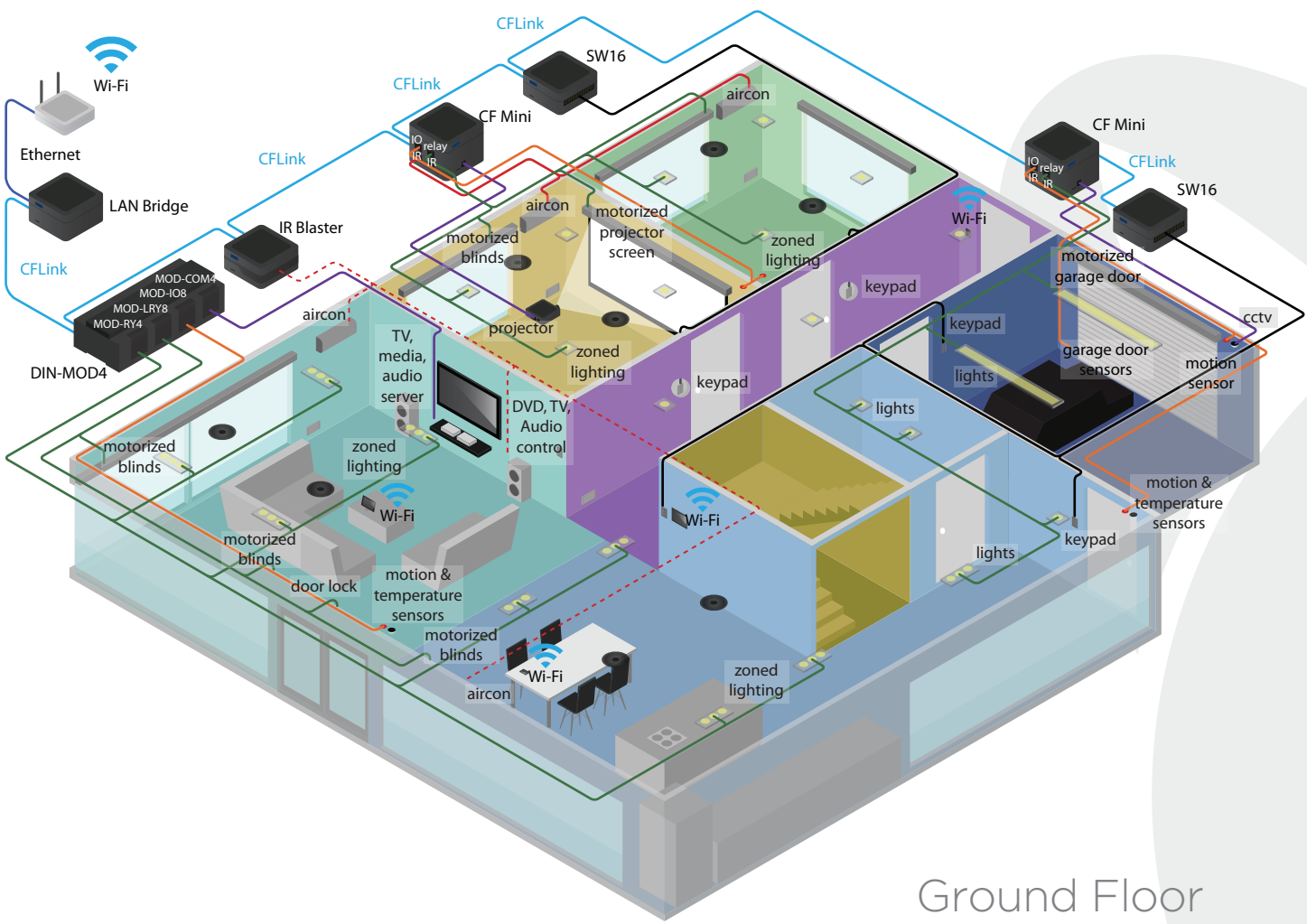

Ground Floor

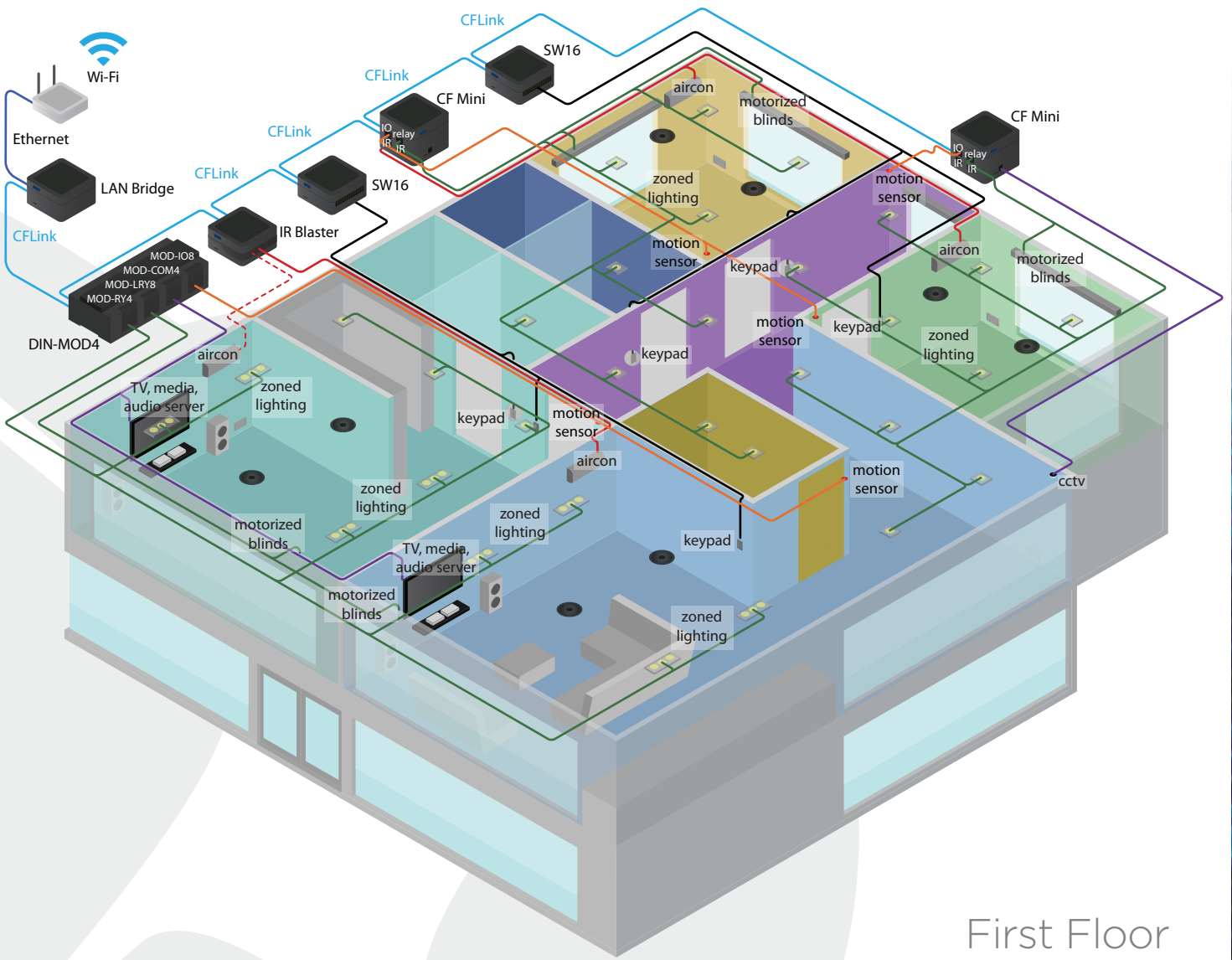

First Floor

Commercial Office Building Application Diagram

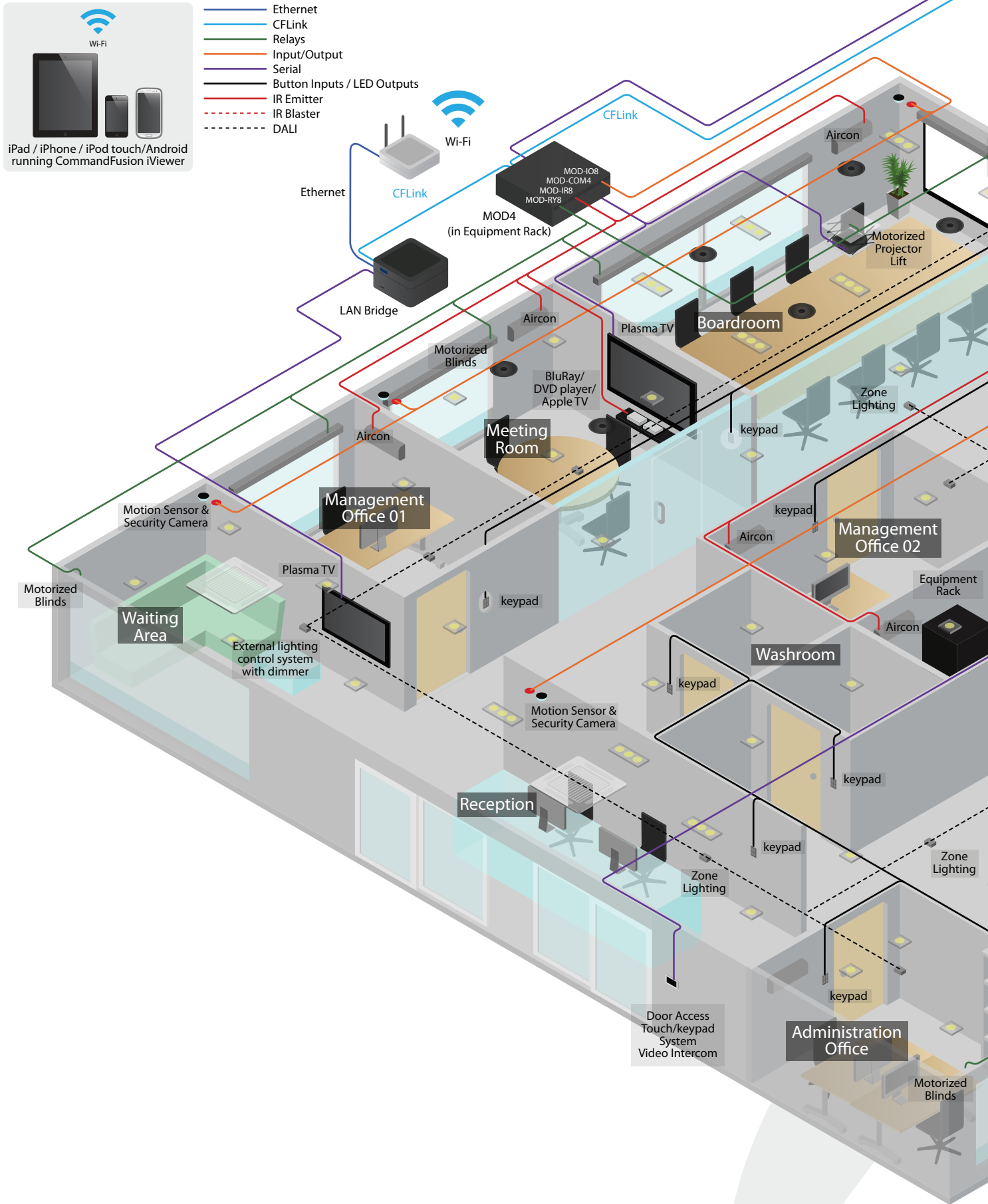

Equipment Rack

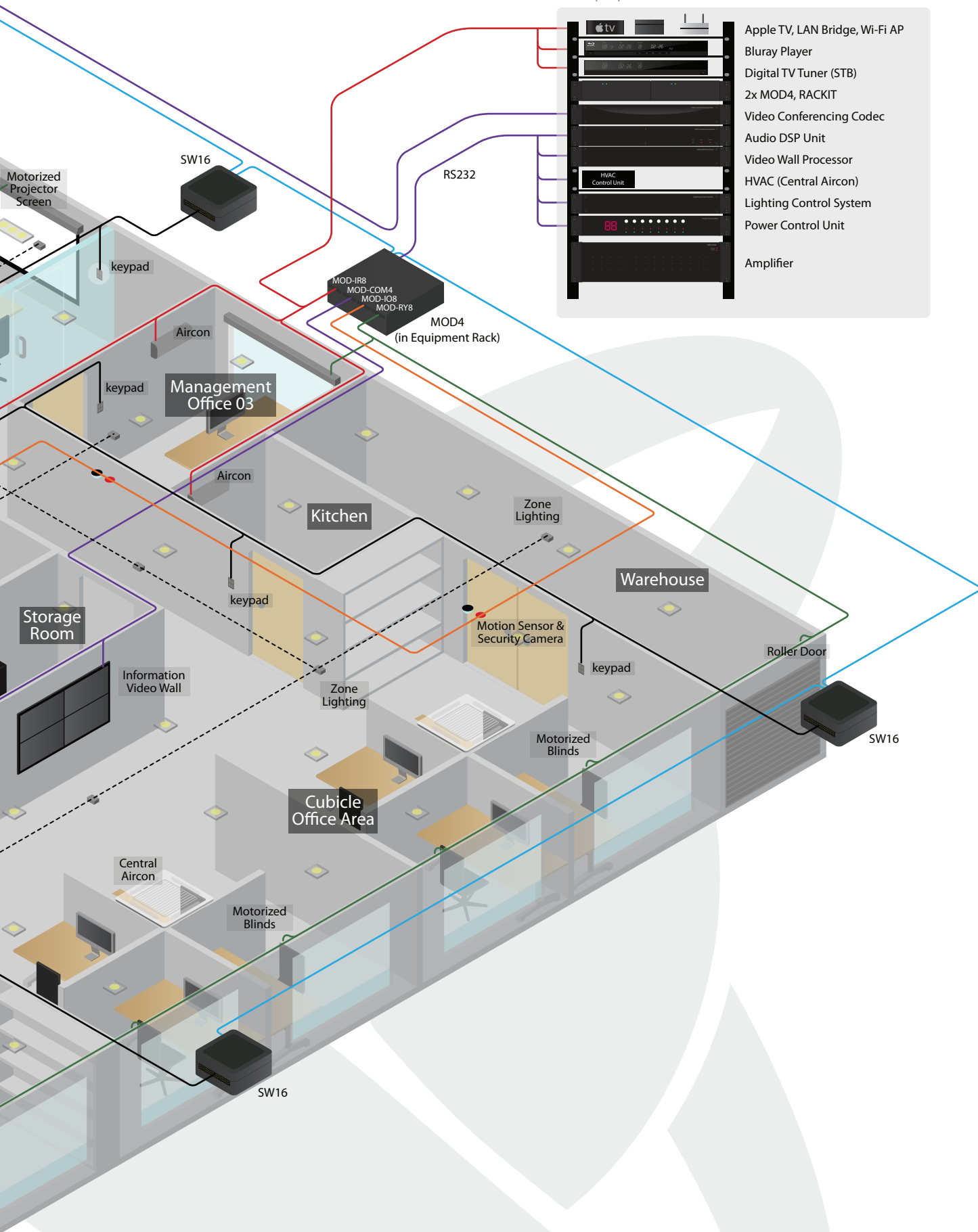
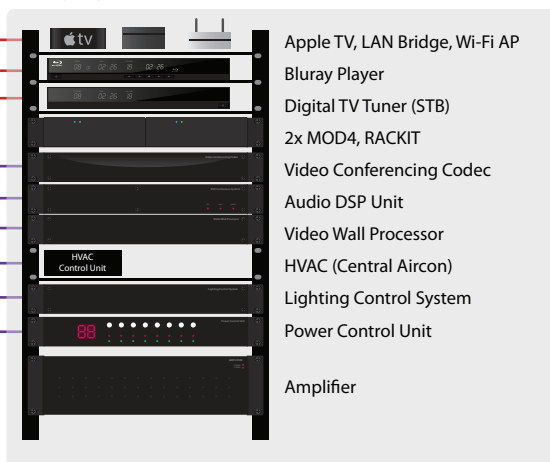

Boardroom Application Diagram

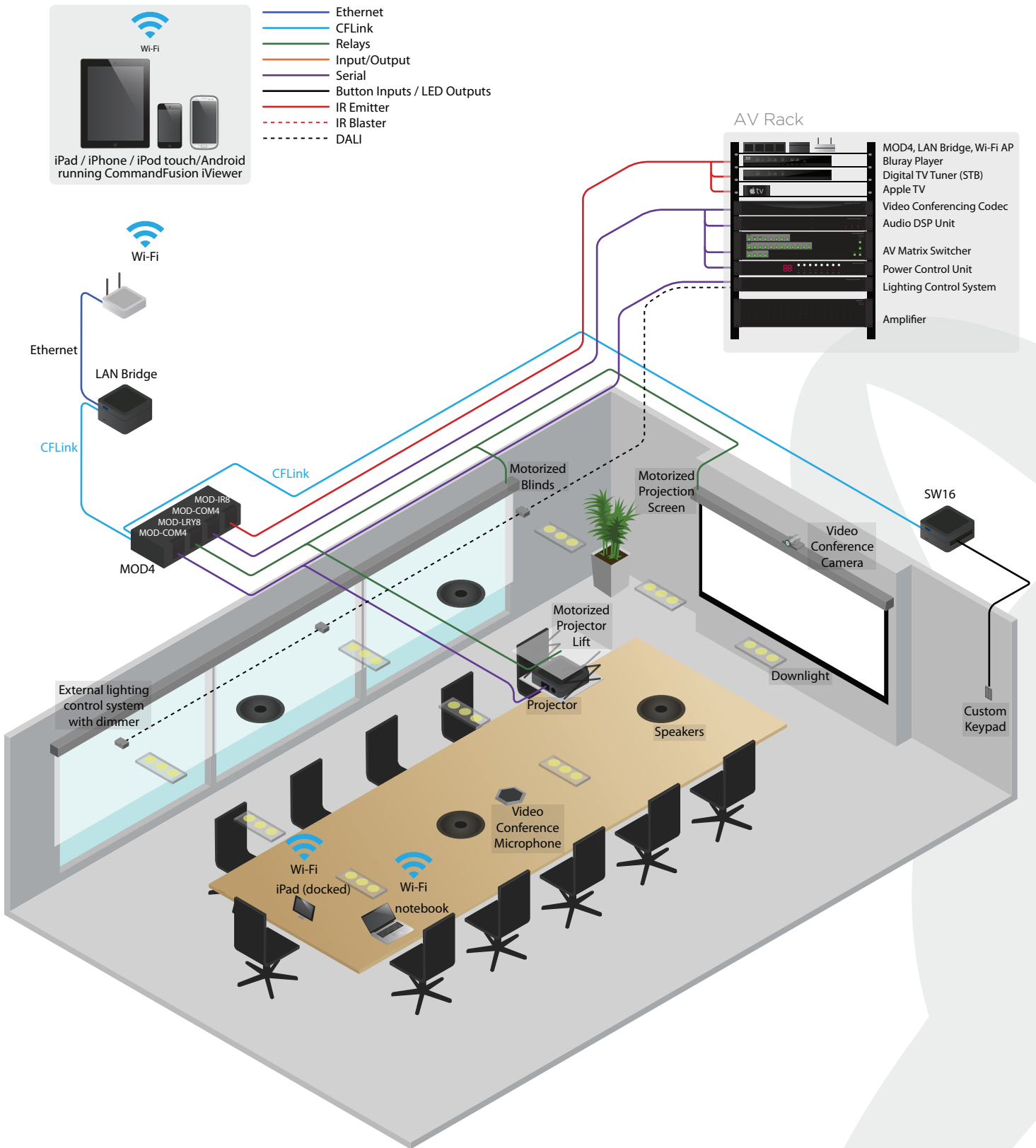



www.commandfusion.com.au